

# TECHNICAL DATASHEET



## WYE TEE 45°

03 Update - 06/2022

### TECHNICAL DATA

Article No	001 317 0045 0063
d (mm)	180
L (mm)	578
le (mm)	110
Z (mm)	394
s (mm)	16,4
Weight (Kg)	8,610
Box Quantity (pcs)	20
Box Dimension (pcs)	80x120x100

### IDENTIFICATION OF PRODUCT

D(mm)	180
SDR	11
RAW METARIAL	PE -RT
PRESSURE CLASS	
TRADEMARK	NTG
EXECUTION	Injection Moulded
STANDARD	ISO 22391

### INJECTION MOULDED

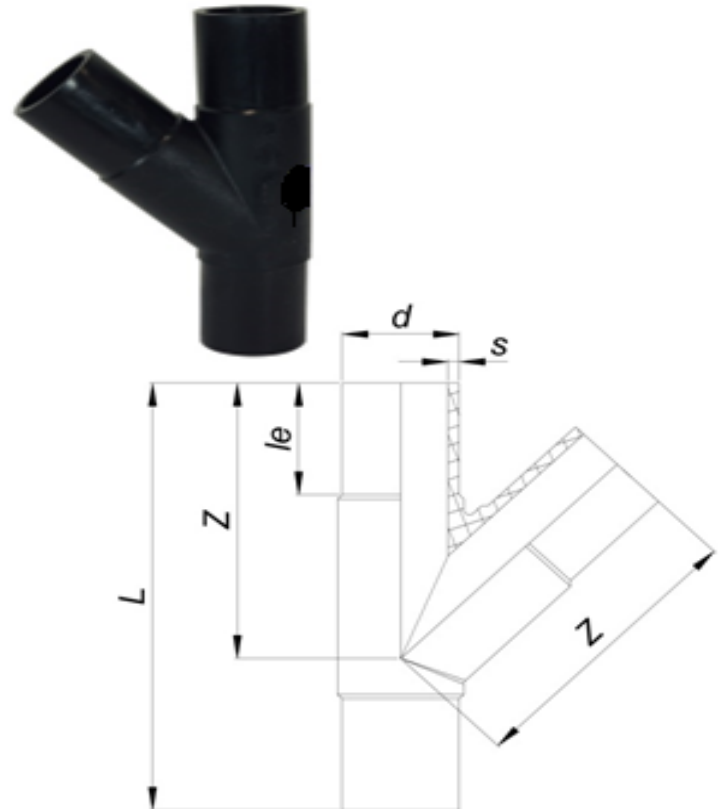

### SPECIFICATION

Long Spigot

Tolerance on diameters and thickness according to the standards. The other dimensions are specialized. Tolerance  $\pm 5\%$ . NTG PLASTIK reserves all the right to change any information without giving prior notice. The production, distribution and utilization of this document without explicit authorization is prohibited.